

Shapes

Full Color

The Acoufelt Shapes collection represents a series of shapes made from acoustic FilaSorb™ material, which can be applied as a fun and functional decorative wall feature. Shapes offer flexibility in design through the wide range of tessellation application options. Acoufelt Shapes have strong acoustic properties and achieve a minimum Noise Reduction Coefficient (NRC) of 0.45. The Collection is available in 6 shapes: Diamond, Ogee, Hexagon, Rectangle, Scale and Right Triangle, and offered across our full range of colours. Custom cutting and sizing available on request.

FILASORB™

FilaSorb™ is made from a substantially heterogeneous blend of fine fibers; different denier combined for specific acoustic results. This combination of fine fibers results in a high active surface area for sound absorption, enhanced resistivity, and a greater interface area for dispersion of noise. This means that products made from FilaSorb™ have been designed for superior acoustic performance.

Key features:

-  Made from FilaSorb™
-  Breathable
-  High resistance to fire
-  Smooth surface finish
-  Thermal efficiency
-  Certified low VOC
-  10 year lightfastness warranty
-  Made with recycled content
-  Bevelled edges
-  Peel and Stick backing
-  Custom available

Specifications

Surface	Wall	
Composition	100% polyester	
Material	FilaSorb™	
Recycled Content	60% min.	
	METRIC	IMPERIAL
Weight	2400 g/m ² +/- 10%	0.49 lb/ft ² +/- 10%
	4800 g/m ² +/- 10%	0.98 lb/ft ² +/- 10%
Shape Size (W x H)		
Rectangle	850mm x 400mm	33" x 16"
Right Triangle	300mm x 400mm	12" x 16"
Hexagon	315mm x 400mm	47" x 16"
Diamond	350mm x 350mm	14" x 14"
Scale	400mm x 317mm	18" x 12"
Ogee	315mm x 400mm	47" x 16"
Thickness	12mm +/- 10%	0.47" +/- 10%
	24mm +/- 10%	0.94" +/- 10%
Fire Testing	ISO 9705: 1993 Group 1 AS ISO 9705: 2003 Group 1 ASTM E84-17a Class A	
Indoor Air Quality	Low VOCs emission, formaldehyde and Phenol-free	
Light Fastness	ISO 105-B02 1994, 6-7	

Environmental

'Declare' certification, LCB Red List Free, free from phenol and formaldehyde, low VOC, CDPH compliance, USGBC accredited and recognised under LEED.



Declare.

Acoustic Performance

Sound Absorption Material NRC 0.45
ISO 354-2006

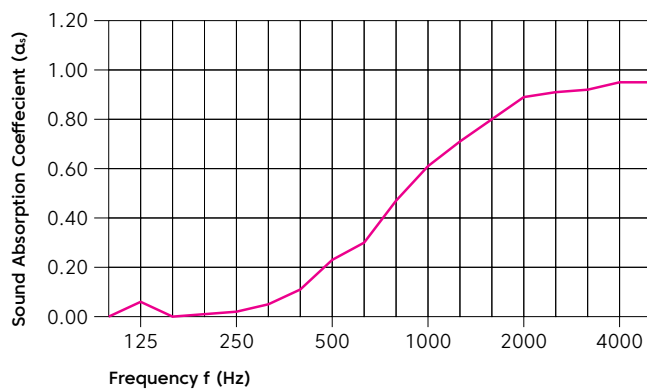

*Graph not to scale.

Frequency (Hz)	125	250	500	1000	2000	4000	NRC
α _s no air gap	0.06	0.02	0.23	0.61	0.89	0.95	0.45

For further product information visit acoufelt.com

Colorways



Lipstick Carrot Butter



Wasabi Denim Azur



Marine Midnight Piano

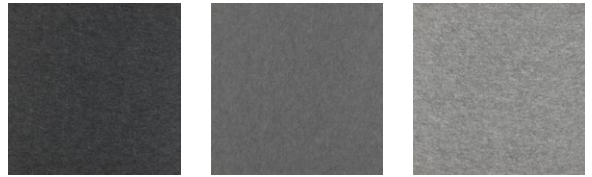

Charcoal Slate Gray



Metal Platinum White



Ivory Pearl

Shapes

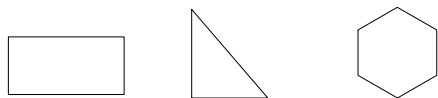

Rectangle Right Triangle Hexagon



Diamond Scale Ogee

Specifications are based on average from normal manufacturing tolerances, such variations do not effect product performance. We reserve the right to improve the specification of the product without prior notice. Acoufelt strives to fulfill the needs of their customers by producing the highest quality felt products. However due to the fine, fibrous and textural nature of the product, slight visual imperfections may be seen when viewing the product from less than 1 to 1.5 meters. These slight visual imperfections however, are within normal industry manufacturing tolerances.

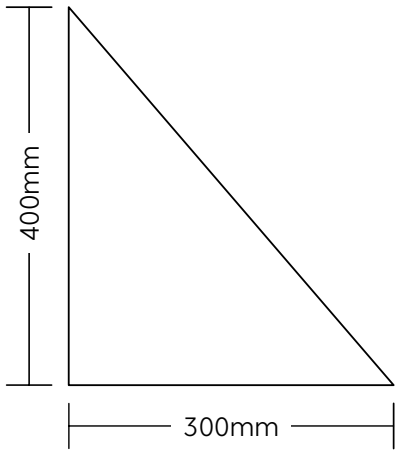
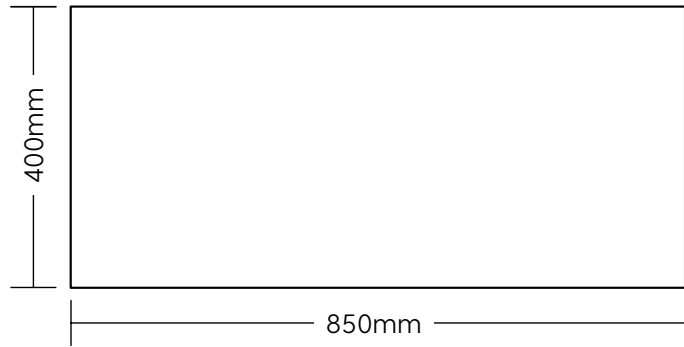
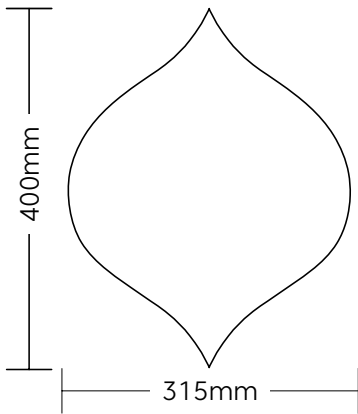
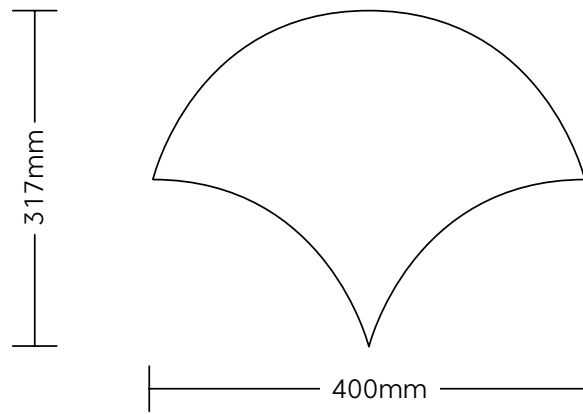
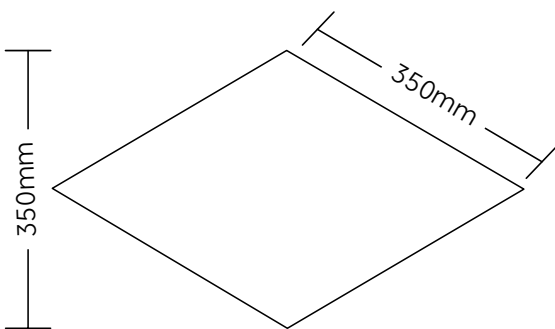
Right Triangle**Rectangle****Ogee****Scale****Diamond****Hexagon**